

Hotel Rooms in Nature

Cabins for
Nature Resorts and
Glamping sites



LUSHNA
Glamour of Nature



Lushna
Aframe
Air

Lushna Aframe Air includes

5.100,00 €

Construction and materials

- Glue laminated solid wood (BSH) frame construction

Roof and Exterior

- Water-repellent poly-cotton roof canvas 420 g/m2 (breathable, water-, mildew and dirt repellent)
- Frontside entry and backside window canvas with zips (replaceable): Water repellent poly-cotton roof canvas 420 g/m2

Exterior frames

- Wood triangle decorative thermo pine frame

Interior

- Interior cotton canvas 125 g/m2 layer
- Mosquito net cotton layer attached to interior layer

Floors

- Solid spruce wood floor 40 mm thickness with visual quality, lacquered

Installations

- A fuse box local standard
- General lighting and 2 x power extension cords with 3 power sockets

Foundations support

- Steel adjustable beam bases for the foundation support

Furniture and equipment

730,00 €

- Solid wood bed frame 180 x 200 cm
- Power sockets integrated in the bed frame

Delivery and installation

TBD

The unit is delivered flat-packed in a box with an instruction manual for assembly by a client. Price of delivery depends on the delivery location and number of units.

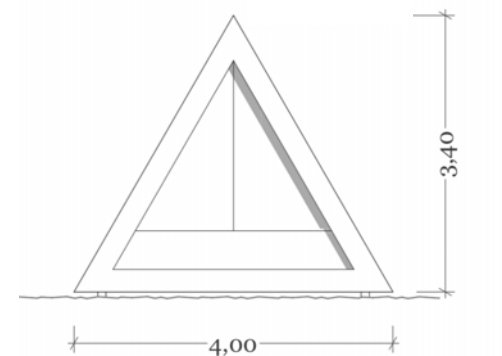
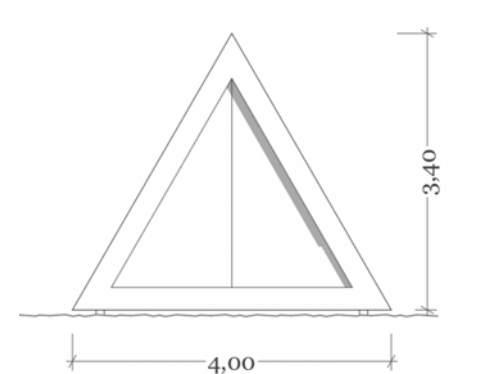



Lushna
Suite
Mezzanine

Lushna Suite Mezzanine includes

54.950,00 €

Construction and materials

WOODSMART® 7 layer construction system

- Interior: Walls spruce wood cladding painted
- Vapour stop control layer
- Steico® Eco 120 mm wooden fibres insulation
- Spruce light-frame wooden structure
- OSB structural boards plates
- Transpir membrane resistant to UV and roof EPDM
- Exterior ventilated facade:
 - Thermo pine wood vertical and horizontal battens
 - Exterior facade and roof in thermo pine wood

Windows /glass

- 3-wing double-glazed front glass door with wooden frame
- Fixed triangular double-glazed glass with wooden frame above in front and at the back in mezzanine floors
- Full-wall side fixed double-glazed glass x 2

Doors

- Entry double glazed glass doors with wood frame with electronic key pad lock
- 2 x Interior glass doors

General installations

- Water and sanitary installation with connections
- Electrical installation with electric fuse box
- Electric ventilation
- Electric water heater - boiler 120 l
- General lighting & LED lights bathroom / kitchen / porch
- Sockets, switches and decorative masks

Indoor accessories

3.910,00 €

Kitchen

- Built-in glass ceramic plate with 2 cookers
- Refrigerator
- Countertop dishwasher
- Kitchen hood (air ventilation)

Mezzanine floor

- Back window curtain
- Child-protective net over stairs
- Floor lead lights

Terrace

2.550,00 €

Terrace is made from thermo pine wood boards on a wooden sub-structure with a textile net fence

Delivery and installation

TBD

Price of delivery and installation depend on the delivery location and number of units.

Furniture and equipment

Bathroom

- Ceramic floor and partially walls
- Walk-in ceramic shower floor
- Glass shower cabin with shower handheld system
- In-wall flush toilet system, ceramic toilet bowl
- Ceramic washbasin with a faucet and an under-sink cabinet
- Bathroom eq: Mirror 110 x 100 cm, hangers Lushna design

Living room

- Wardrobe with open shelves 100 x 201 cm

Kitchen

- Ceramic floor and partially walls
- Kitchen cabinets and kitchen countertop
- Kitchen stainless steel sink with a faucet

Mezzanine floor

- Stairs
- Wooden floor deck

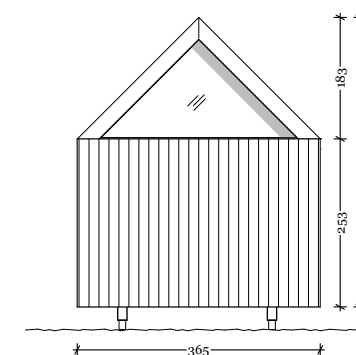
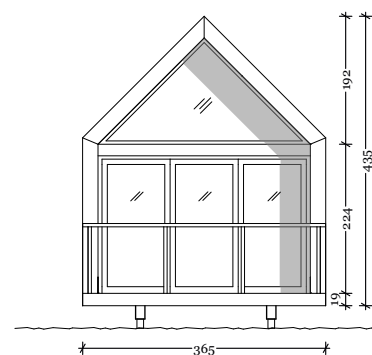
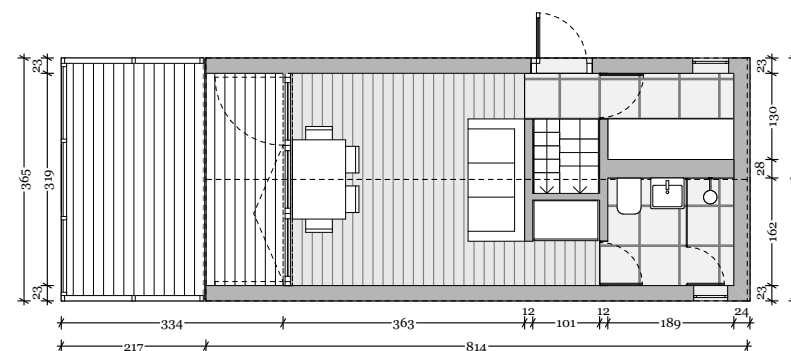
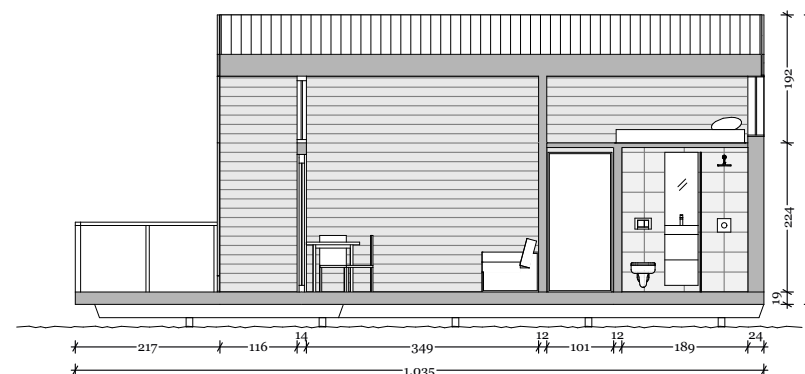

LUSHNA®



Lushna
Petite
Life

Lushna Petite Life includes

34.600,00 €

Construction system and materials

WOODSMART® 7 layer construction system

- Interior: Walls and floors spruce wood cladding painted
- Vapour stop control layer
- Steico® Eco 120 mm wooden fibres insulation
- Spruce light-frame wooden structure
- OSB structural boards plates
- Highly breathable membrane resistant to UV and roof EPDM
- Exterior ventilated facade:
 - Thermo pine wood vertical and horizontal battens
 - Exterior facade and roof in thermo pine wood

Window / glass

- Front fixed double glazed glass with a thermo pine wood frame
- Double glazed glass window on back side of the object

Doors

- Entry Double glazed glass doors with wood frame
- Steel door handle with a cylindric lock
- Secondary covering doors from thermo pine boards
- Interior glass doors to bathroom

Mechanical, electrical and sanitary installations

- Water and sanitary installation with connections
- Electrical installation with electric fuse box
- Electric water heater - boiler 80 l
- General lights & LED lights shower / toilet / exterior
- Sockets, switches and decorative masks white

Indoor accessories

1.680,00 €

Living space / kitchenette

- 1 x front full window dim curtain fire retardant
- 2 x night reading lights

Terrace

2.550,00 €

Terrace is made from thermo pine wood boards on a wooden sub-structure with a textile net fence

Delivery and installation

TBD

Price of delivery and installation depend on the delivery location and number of units.

Furniture and equipment

Bathroom:

- Ceramic floor and partially walls
- Walk-in ceramic shower floor with glass shower wall
- Shower hand held system Hansgrohe high-mid range
- In-wall flush toilet system Geberit, ceramic toilet bowl and lid
- Ceramic washbasin with a faucet Hansgrohe and an under sink cabinet
- Mirror 112 x 40 cm
- Wall shelves for accessories

Smart box kitchen furniture

- Folding table + wardrobe + hidden kitchenette in the cabinets

Living room

- 1 x sleeping wooden platforms

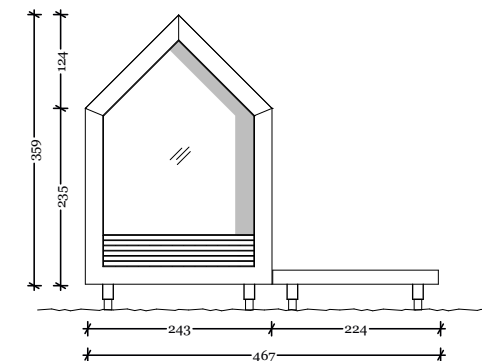
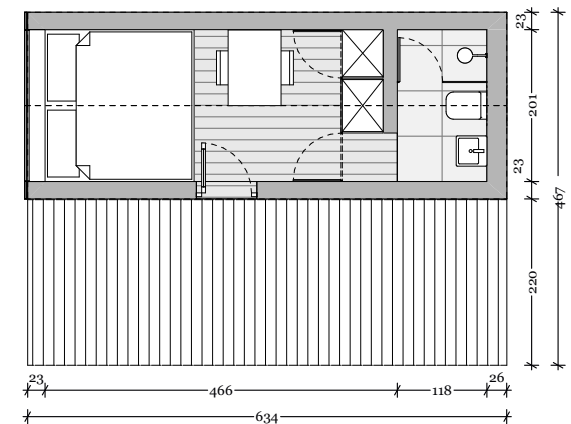
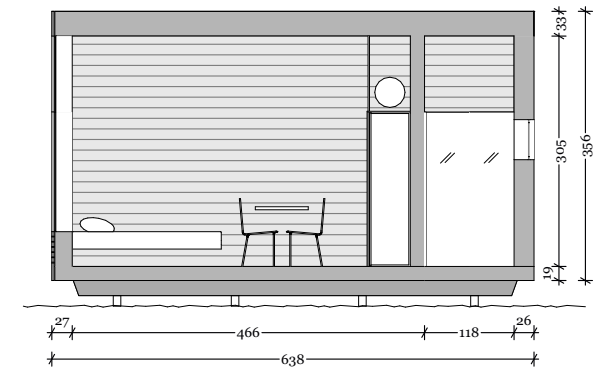

LUSHNA®



Lushna
Aframe
Icon

Lushna Aframe Icon includes

18.200,00 €

Construction system and materials

WOODSMART® 7 layer construction system

- Interior: Walls spruce wood cladding oiled,
- Vapour stop control layer
- Steico® Eco 120 mm wooden fibres insulation
- Spruce light-frame wooden structure
- OSB structural boards plates
- Roof waterproof EPDM membrane and porch wall transpir membrane
- Exterior ventilated facade:
 - Thermo pine wood vertical and horizontal battens
 - Exterior facade and roof in thermo pine wood

Exterior

- Roof cladding: Thermo pine shingles / thermo pine boards
- Porch: Thermo pine boards cladding and terrace floor

Panoramic window

- Double glazed fixed glass wall with wooden frame

Interior

- Wooden bed platform 260 x 200 cm

Entry doors

- Massive solid wood doors
- Door handle with a cylindric lock

Installations

- Electrical installation with electric fuse box
- General lighting
- Exterior LED lighting
- Natural ventilation system

Interior accessories

750,00 €

- Triangle curtain for the triangle panoramic window
- Power sockets integrated in the bed structure

Delivery and installation

TBD

Price of delivery and installation depend on the delivery location and number of units.

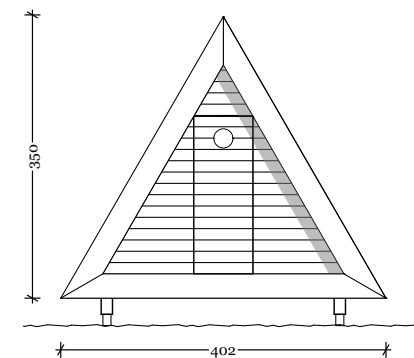
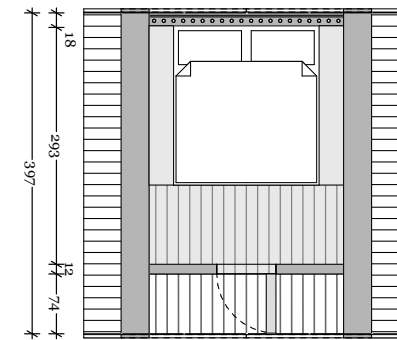
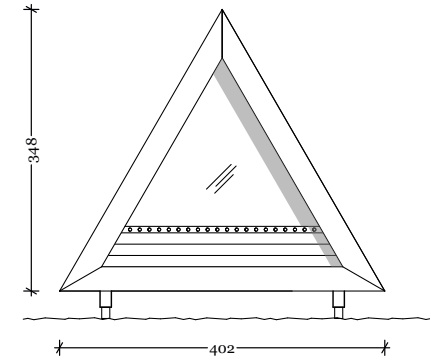

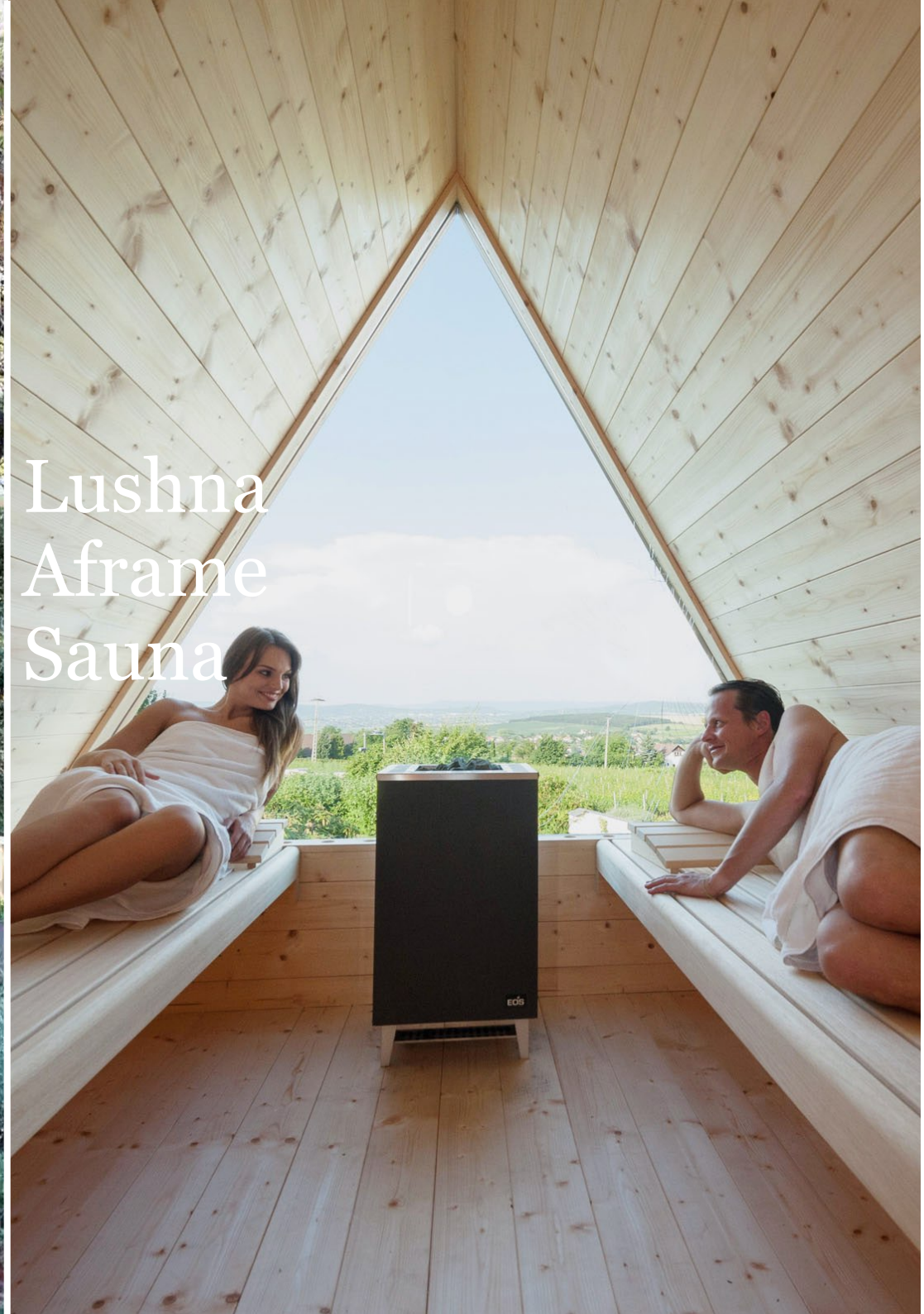

Lushna
Aframe
Sauna

Lushna Sauna includes

21.300,00 €

Construction system and materials

WOODSMART® 7 layer construction system

- Interior walls: Thermo pine or Hemlock wood
- Interior floors: Ceramic tiles
- Vapour stop control layer
- Steico® Eco 120 mm wooden fibres insulation
- Light-frame wooden structure
- OSB wooden plates
- Roof waterproof EPDM membrane and porch wall transpir membrane
- Ventilated facade:
 - Thermo pine wood vertical and horizontal battens
 - Exterior Thermo pine wood cladding AB quality

Exterior

- Roof cladding: Thermo pine shingles / thermo pine boards
- Porch: Thermo pine boards cladding and terrace floor

Panoramic window

- Double glazed glass layer front wall with wooden frame

Entry doors

- Massive solid wood doors
- Door handle with a cylindric lock

Equipment

- EOS Saunatechnik CUBO Elec. heater 9kW for Finnish sauna
- Digital Control unit and thermostat
- Controlling and programming of sauna and lighting (Life guard and auto stop functions)

Furniture

- 2 x wooden benches
- 2 x wooden pillows
- Wooden water bucket
- Thermometer and humidity meter

Installations

- Electrical installation with electric fuse box
- Interior LED line lighting
- Exterior LED lighting
- Natural ventilation system

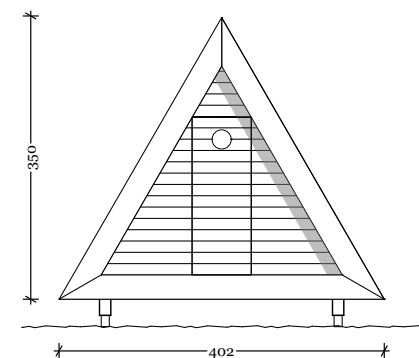
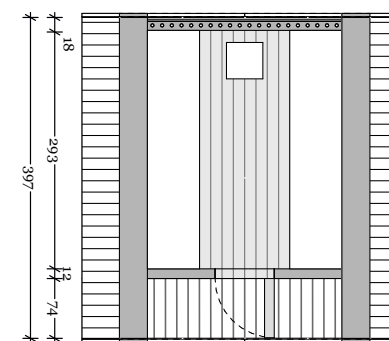
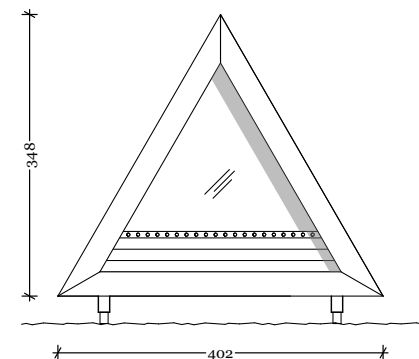

Delivery and installation

TBD

Price of delivery and installation depend on the delivery location and number of units.

LUSHNA®



Lushna
Aframe
Saltroom

Lushna Saltroom includes

22.750,00 €

Construction system and materials

WOODSMART® 7 layer construction system

- Interior walls: Salt covered walls
- Interior floor: Spruce wood
- Vapour stop control layer
- Steico® Eco wooden fibres insulation
- Light-frame wooden structure
- OSB wooden plates
- Roof waterproof EPDM membrane and porch wall transpir membrane
- Ventilated facade:
 - Thermo pine wood vertical and horizontal battens
 - Exterior Thermo pine wood cladding AB quality

Exterior

- Roof cladding: Thermo pine shingles / thermo pine boards
- Porch: Thermo pine boards cladding and terrace floor

Panoramic window

- Double glazed fixed glass wall with thermo pine wood frame

Entry doors

- Massive solid wood doors
- Door handle with cylindric lock

Equipment

- PrizSaltz salt aerosol halogenerator
- LCD touch screen control or Mobile app controlled unit
- Dehumidifier device

Furniture

- 2 x wooden benches, 2 x latex pillows

Installations

- General lighting and wall power sockets
- Robust Fuse box
- Exterior LED lighting
- Natural ventilation system

Delivery and installation

TBD

Price of delivery and installation depend on the delivery location and number of units.

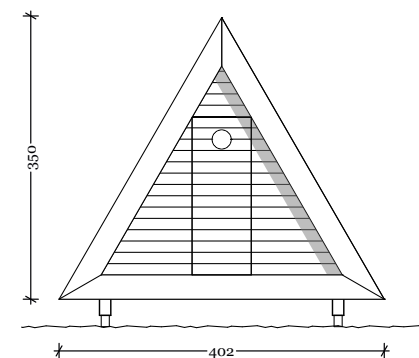
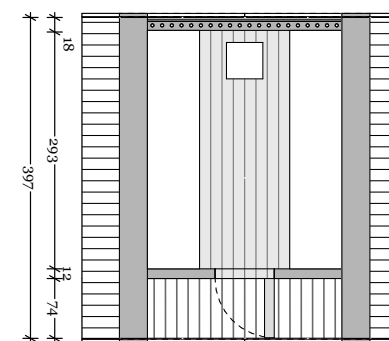
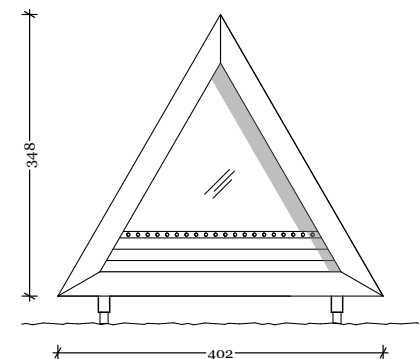



Lushna Rainroom

Lushna RainRoom Bathroom includes

23.760,00 €

Construction system and materials

WOODSMART® 7 layer construction system

- Interior walls: Ceramic tiles and partially spruce wood cladding painted
- Interior floors: Ceramic tiles
- Vapour stop control layer
- Steico® Eco 100 mm wooden fibres insulation
- Spruce light-frame wooden structure
- OSB structural boards plates
- Highly breathable membrane resistant to UV and roof EPDM
- Exterior ventilated facade:
 - Thermo pine wood vertical and horizontal battens
 - Exterior facade and roof in thermo pine wood

Roof panoramic window

- Panoramic fixed roof double glazed glass window
- Thermo pine boards

Entry doors

- Massive wood doors
- Door handle with cylindric lock

Equipment

- Walk-in ceramic shower floor
- Glass shower cabin with shower hand held system Hansgrohe chrome
- In-wall flush toilet system, ceramic toilet bowl with a lid
- Sink with a faucet
- Cabinets
- Mirror

Installations

- General lighting and electric power sockets
- Electric water heater - boiler 80 l
- Exterior LED lighting
- Robust Fuse box

Delivery and installation

TBD

Price of delivery and installation depend on the delivery location and number of units.

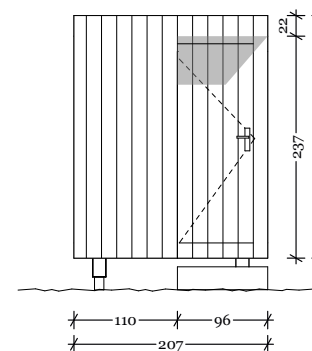
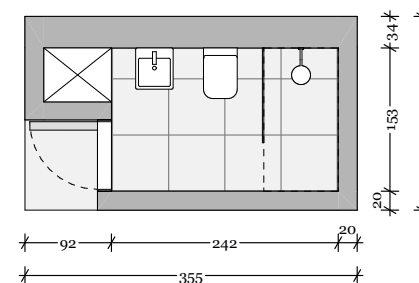
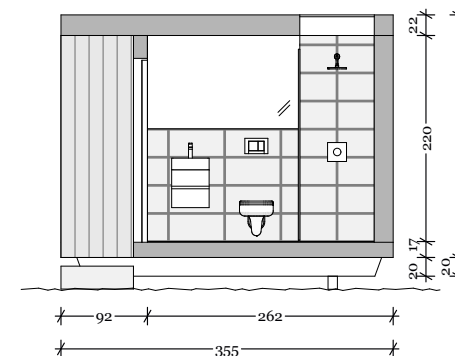

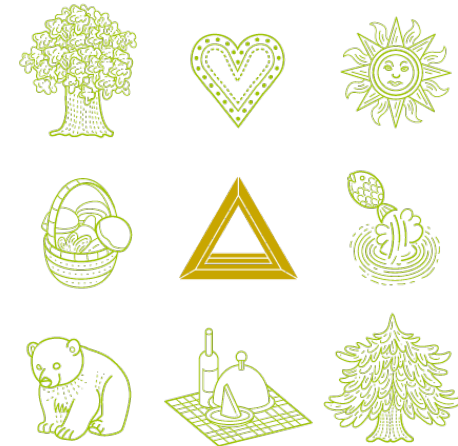

LUSHNA®

Contact:

Lushna d.o.o.

Cesta Franceta Preserna 58
4270 Jesenice
Slovenia, EU

T: +386 30 440 330

E: info@lushna.com

W: www.glamping-lushna.com

Disclaimer: All prices in the price list are without TAX (VAT).

The prices in the price list are informative and may be changed at any time without further notice.

We reserve the right to change our product's prices at any time without further notice.

All the additional equipment like linen, mattresses, pillows, sunscreens, outdoor furniture not included.